

QUADRATURE HYBRIDS

90° POWER DIVIDERS/COMBINERS

10 kHz to 40 GHz

GENERAL INFORMATION

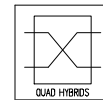

General Discussion

Merrimac 90° Power Dividers/Combiners are four port networks capable of operating from 10 kHz to 40 GHz and available in a wide variety of package options. These devices can perform two complementary functions:

a) **Power Divider:** One function is to equally divide an input signal into two output signals while imparting to one of the outputs a 90° phase shift with respect to the phase of the other output. Thus, the outputs exhibit a quadrature relationship meaning their respective phases differ by one “quadrant” or simply 90°.

b) **Combiner:** The complementary function is to combine two equal amplitude, quadrature-phased input signals into a single output signal.

The 90° Power Dividers/Combiners included in this catalog employ either lumped element circuits or stripline circuits. Using lumped element circuitry allows realizing *microwave-type* structures at frequencies as low as 10 kHz. Moreover, using lumped element circuits avoids the usual size penalties normally associated with circuits whose dimensions are closely related to wavelength.

In contrast, stripline circuit techniques are generally more useful at frequencies above 0.5 GHz and in applications requiring very low loss or high power (or both). The fundamental circuit element is the 3 dB quarter-wave coupler schematically illustrated in Figure 1.

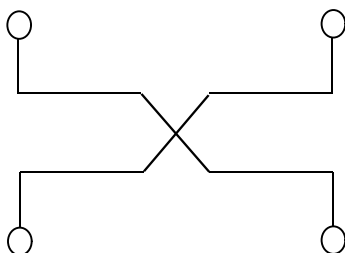

Figure 1: Quarter Wave Coupler

All 90° Power Dividers/Combiners, also known as quadrature hybrids or simply quad hybrids, are reciprocal

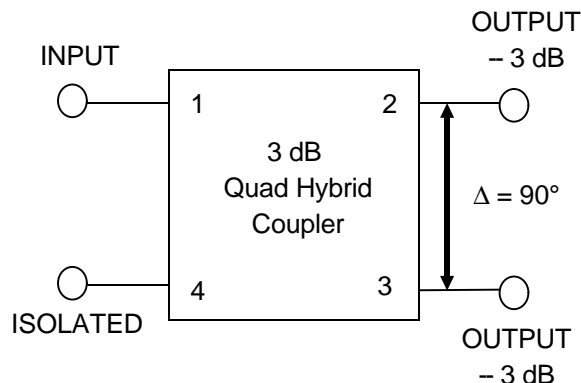

Figure 2: Functional Block Diagram

four port networks. Figure 2 is a functional block diagram of a 3 dB quad hybrid coupler.

Referring to Figure 2, a signal applied to port 1 splits equally between ports 2 and 3 with one of the outputs exhibiting a relative 90° phase shift. If ports 2 and 3 are properly terminated into matching impedances, nearly all the signal applied to port 1 is transmitted to the loads connected to ports 2 and 3. In this circumstance, port 4 receives negligible power and is termed “isolated”. However, if there is an impedance mismatch at port 2, for example, then signal power reflected back from port 2 will be divided proportionally between ports 1 and 4. Power is not fed to port 3.

Although the relationship between the output ports is always maintained at 90°, the relative input/output phasing of Merrimac 90° Power Dividers/ Combiners varies. Table 1 illustrates the phasing arrangement of a typical octave

	1	2	3	4
1		0°	- 90°	Isol
2	0°		Isol	- 90°
3	- 90°	Isol		0°
4	Isol	- 90°	0°	

Table 1: Typical Phasing Arrangement

bandwidth unit. Most quad hybrid coupler data sheets include this type of I/O phasing information. Consult the factory when additional information is required.

Lumped Element Construction

Lumped element devices consist of one or more toroidal cores each wound with several turns of fine wire to form a transformer. The number of transformers required depends on a large number of factors such as required bandwidth, power levels and circuit configuration. The cores are generally sufficiently small so as to allow a single or double section device, usually on a small printed circuit card, to be mounted inside a TO-5 can or a 0.5" (13 mm) by 0.375" (10 mm) Flatpack or Meri-Pac™. This type of construction is best suited for commercial, military and Hi-Rel applications including space applications. For less stressful environments these devices are available in relay header and PC housings.

For prototyping and high circuit isolation applications, Merrimac also has a full line of connectorized packages to suit most requirements.

Stripline Construction

In stripline quad hybrid couplers, Merrimac offers a wide variety of packages providing maximum flexibility in layout for engineers with responsibility for sub-system and system packaging.

The simple tab connected, sandwich style units, such as the QHF Filmbrid™ series, are inexpensive and reliable for integration into production systems. A smaller sized unit, the QHD Mini-Filmbrid™, further reduces unit size by using IC-type processes to precisely control tolerances. Connectorized styles such as the QH/QHM series are convenient for prototyping and production systems. Fully encapsulated packages are also available for Hi-Rel applications.

Materials used in quadrature hybrid coupler construction include low loss PTFE (PolyTetraFluoroEthylene, e.g., Teflon) impregnated fiberglass laminates (both woven and non-woven), glass filled, cross linked polystyrenes, pure PTFE and ceramic composites. These dielectrics are generally used to separate two identical circuits coupled to each other through precise registration.

All circuit board and cover board assemblies are thermally bonded under heat and pressure producing an integrated, laminated stripline package. The completed device is highly resistant to infiltration of dust and moisture.

All circuit attachments are positively achieved through direct connection not relying on pressure contact alone. For example, tabs are connected to the circuit using parallel gap

welds and connector pins are attached to the circuit board using either parallel gap welds or solder. All connectors comply with the interface requirements of MIL-C-39012 and are generally constructed with a two part center pin. The center pin has a male-female interconnect within the connector so that the interface portion can be captivated. The male-female internal interconnect connection to the attached circuit allows for thermal expansion without stress and the consequential risk of thermal stress fracturing at the interconnect.



90° Power Divider Applications

As mentioned briefly above, one characteristic of 90° quadrature hybrid couplers is the signal relationship between the various ports when they are subjected to various degrees of impedance mismatch. Many applications for these devices arise from their ability to provide a high degree of port-to-port isolation even while the ports are terminated in a mismatch.

Another useful aspect of quadrature hybrids is illustrated when both ports 2 and 3 are terminated in identical mismatches. In this circumstance a signal source connected to port 1 sees a 50 Ω impedance regardless of the degree of mismatch at ports 2 and 3. This capability is valuable in interfacing drivers with parallel power amplifiers, for example.

As shown in Figure 3, with a common load mismatch, as might be experienced in an amplifier driver, reflections

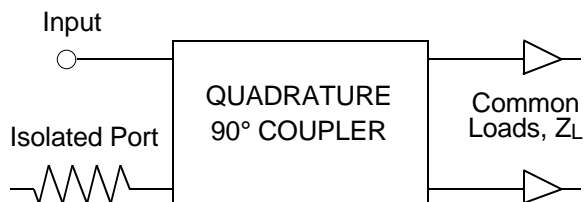

Figure 3. Common Source Mismatch

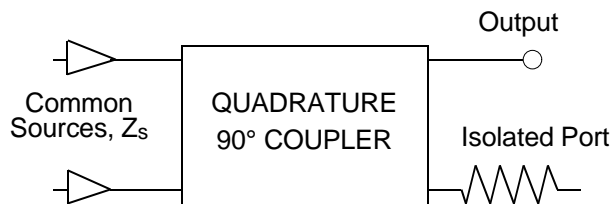

Figure 4: Common Load Mismatch

combine at the isolated port while canceling at the input, so the match to the driving system is unaffected.

A similar situation arises in the case of source mismatches as shown in Figure 4 where reflections are combined at the isolated port; not at the output.

Classes Of Quadrature Hybrids

The required amplitude balance precision of the quad hybrid largely determines the number of sections and thus its complexity.

10% Bandwidth Models

Merrimac 10% bandwidth models are single section or single crossover devices with coupling characteristics as illustrated in Figure 5. These devices are suitable for high performance at a specific frequency and are available in various packages. Narrowband models are found exclusively in lumped element designs and are identified in this catalog by a -2 following the series identification, e.g. QHS-2 Series.

30% and Octave Bandwidth Models

Merrimac 30% and octave bandwidth models usually exhibit coupling characteristics similar to Figure 6. The amplitude response is described as an over coupled single section or dual crossover networks, capable of yielding from 0.3 to 1.0 dB peak-to-peak amplitude balance, depending on the relative bandwidth percentage. When found in lumped element circuits, this class of couplers is designated with -23 and -3. Stripline units are designated with a -2. The stripline -3 series have three or more sections with performance similar to Figure 8 and provide more than an octave bandwidth.

Limitations and Trade-offs in Custom Design

Multi-Octave Bandwidth Models

Multi-octave models with bandwidth ratios up to 300:1 are available from Merrimac. These quadrature hybrids, known as “multi-section” networks, are cascaded single section elements of various resonant frequencies. The quantity of sections in the string is related to the required amplitude balance and bandwidth. Models in the class include both lumped element units covering up to 1 GHz and stripline models covering up to 49 GHz.

Operating Frequency Bounds

In stripline models, overall unit dimensions are directly proportional to wavelength and inversely proportional to

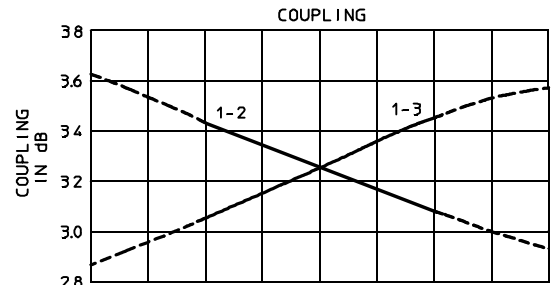
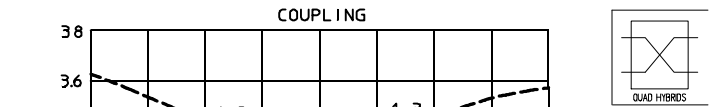

Figure 5. Single Section Characteristics

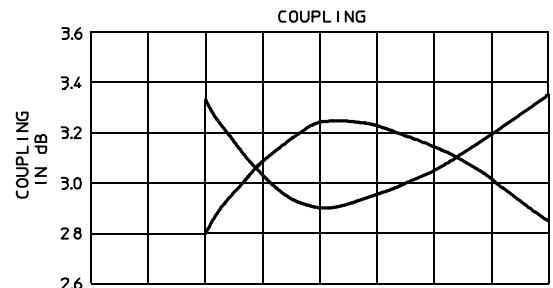

Figure 6. Single Section, Over coupled

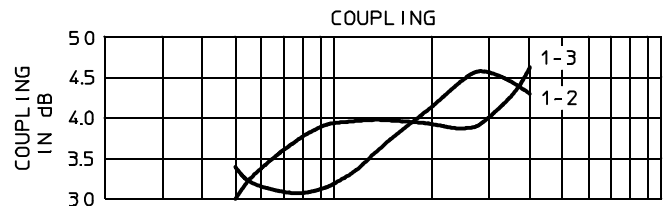

Figure 7. Two Section Characteristics

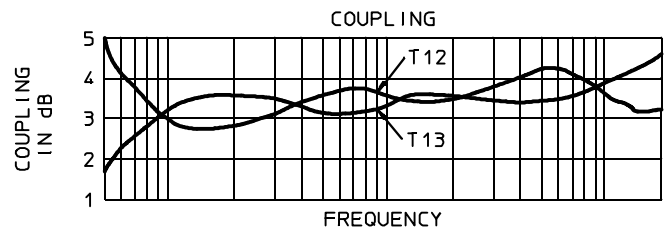
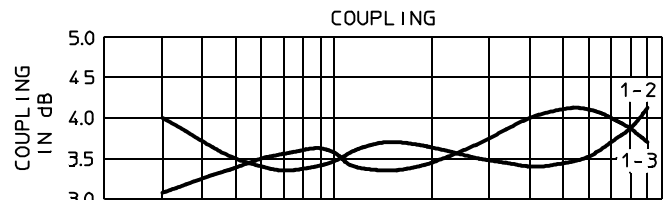

Figure 8. Three and Four Section Characteristics

frequency. For example, the free space wavelength of a 30 MHz signal 10 meters (33 feet). The wavelength is less in stripline because of lower propagation velocity equal to about 70% of the free space velocity. Only by meandering the stripline track can VHF coverage be practically implemented. Thus, line length and the resultant package size effectively establishes the practical lower frequency bound for stripline couplers.

An upper bound on stripline frequency coverage is established by a combination of attainable mechanical precision and losses in available materials. At 18 GHz on a PTFE board, for example, a wavelength is about 11 mm (0.45"). This means that a 10° error (serious in most applications) would result from a mechanical error of only 0.6 mm (0.012").

The low frequency bound of a practical quadrature hybrid built from lumped element circuits is determined by the electrical characteristics of inductors and capacitors. Both capacitors and inductors must have a satisfactory "Q" and temperature stability. In addition, ferrite cores must be operated below their saturation point. Merrimac has built narrowband quadrature hybrids (e.g., QH*-2 series) with center frequencies as low as 1 kHz.

The upper bound on quad hybrids composed of lumped element circuitry is established by the effects of stray capacitance and the self-inductance of transformer wires.

Bandwidth and Output Balance

As mentioned previously, in quad hybrid coupler design there is an inevitable tradeoff between bandwidth and amplitude balance that affects overall unit complexity. For example, if satisfactory amplitude balance is to be preserved across a broader bandwidth, the immediate consequence is an increase in the required number of sections. With an increased number of sections comes an increase in package complexity and size. This, in turn, increases insertion loss. As the package gets progressively larger, so also do the effects of stray capacitances and self-inductance. Therefore, beginning at frequencies in the range of approximately 400 MHz and higher, it is generally desirable to realize quad hybrid couplers in stripline rather than lumped element circuits.

Most stripline designs are single section couplers providing octave band coverage. Multi-octave designs using 3, 5 or more sections generally are larger, have poorer isolation, higher loss and inferior VSWR characteristics. In practice, however, the need for multi-octave bandwidth capacity often offsets these disadvantages. At lower frequencies, lumped element circuits often can avert these

disadvantages providing extremely wide bandwidths (e.g. 125:1 in the QH/QHM-7 series), in very compact packages.

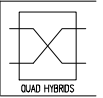

Quadrature

Maintaining precise phase quadrature is generally accomplished by close control of the component tolerances and their Q factors. Size and operating power constraints also affect the choice. For narrowband devices (10% bandwidth or less) quadrature can sometimes be *forced* to a close tolerance. For broadband units, this is generally impossible because of trade-offs between other parameters involved in obtaining close control of phase quadrature tolerance. An additional significant factor in maintaining close quadrature tolerance is the systemic error introduced by even the best available test equipment.

Isolation and VSWR

The isolation between the signal input port and the isolated port is theoretically infinite and frequency independent. However, in a stripline unit, meandering the lines may be necessary to achieve a practical package. However, meandering diminishes isolation due to forward coupling of the signal. Thus, attainable isolation can become a function of operating frequency which is *highly* undesirable.

The quality of the transition between the circuit and connector (or tab) also affects achievable isolation since any impedance discontinuity degrades the VSWR, increases reflections and thus limits achievable isolation. Careful attention to the mechanical design of the accepting circuit greatly enhances the performance of both Mini-Filmbrid and Filmbrid caseless couplers.

Insertion Loss

In lumped element designs, insertion loss is related to the Q values of the components used in the network and is generally limited by the Q value of the transformer core material and wire size. In general, the smaller the units required, the higher the loss.

For stripline components, the insertion loss results from the resistance of the copper conductor, the mismatch loss at input/output ports and the directivity loss. A thicker conductor can reduce the resistance loss and the resultant heat thus increasing power capacity. Other losses can most easily be controlled over narrow frequency bands so overall loss is closely related to performance bandwidth.

Maximum Power Handling

The power capacity of stripline and Filmbrid caseless couplers is largely a function of the materials used. The

effective cross-section of the copper lines (limited by skin-effect) and the electrical conductivity of the copper itself limit the current capacity. The dielectric strength of the dielectric material used (e.g. PTFE) limits the voltage capacity. The design engineer needs to specify average (CW) power, peak power, duty cycle and the thermal environment to insure satisfactory performance as regards power capacity of these units.

For lumped element components, the power capacity is generally dependent on the saturation levels of the ferrite cores at the operating frequency as well as heat dissipation capacity. For example, an insertion loss of 0.5 dB represents about 10% power loss. If all these losses were dissipative (e.g. I^2R loss) and one assumes a power input of 1 kW, 100 W would need to be dissipated in the unit; clearly a complicating factor insofar as design and practical implementation.

Heavy gauge wire is often required to handle the large RF currents associated with high power levels. But along with increased current capacity, because of their increased surface area, large diameter conductors bring increased stray capacitance which imposes an upper frequency bound. Therefore, there is a clear tradeoff between power capacity and achievable frequency in lumped element units in that the higher the power capacity, the more difficult it becomes to achieve satisfactory higher frequency operation.

Contributing to the low frequency bound of lumped element quad hybrid couplers is the potential for core saturation. As the operating band is lowered, the number of coil turns required to achieve a given level of inductance increases. With more turns on a given core, as may be required for satisfactory coupling, magnetic flux density around the core increases and along with it the potential of saturating the core. Saturation results in a host of undesirable consequences. Therefore, the required operating RF power level *and* the magnetic characteristics of the ferrite core material itself contribute to the establishment of a lower frequency bound for lumped element quad hybrid couplers.

Three or Four Port Designs

An improvement in amplitude and phase balance performance can usually be achieved by using an internal termination since it can be matched precisely.

RFI Performance

In the interests of economy, standard catalog products use a simple RFI shielding technique which will typically achieve -50 dBc (decibels referenced to the carrier amplitude). With special attention to mechanical design,

isolation can be raised to -85 dBc or higher, depending on requirements.

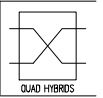

Parameter and Specification Definitions

1. Frequency Range, Performance Bandwidth or Bandwidth

Frequency band over which the given specifications are valid.

2. Amplitude Balance

The peak-to-peak difference between the maximum and minimum coupling values at any frequency within the specified bandwidth expressed in dB.

3. Phase Tolerance (As applies to Quad Hybrid Couplers)

The maximum allowable phase deviation from perfect quadrature (90°) measured in degrees between output ports at any frequency within the specified bandwidth.

4. Isolation (As applies to Quad Hybrid Couplers)

The amplitude difference in dB between a signal appearing at an input port and the amplitude of that signal as measured at the isolated port when both output ports are properly terminated in matched loads.

Additionally, since the quadrature hybrid is a reciprocal device, isolation can also be defined as the amplitude difference in dB between the 0° and 90° ports when using *either of these* as an input and when both the other 2 ports are terminated in matched loads.

Figure 9 graphically depicts the relationship between isolation, coupling and frequency for a typical quad hybrid coupler made by Merrimac.

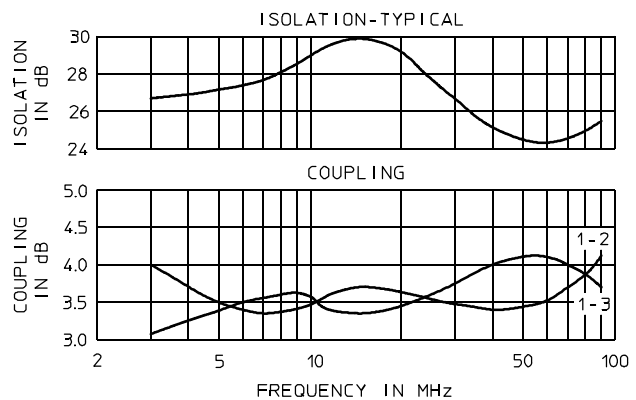

Figure 9. Typical Isolation and Coupling Data

5. VSWR

The maximum VSWR occurring at any port when all other ports terminated in matched loads.

6. Insertion Loss

The difference in dB between the power applied to the input and the sum of power levels appearing at all outputs when all ports are terminated in matched loads. Insertion loss is the net unrecoverable power or simply the difference between what goes in and what comes out.

Applicable Military Standards

All units are designed to meet the requirements of MIL-P-23971 military specification. If required, under special order, the product can be designed, manufactured and tested fully compliant to all requirements of MIL-P-23971.

