

PHASE SHIFTERS

Electronic & Mechanical; Analog & Digital

200 kHz to 3 GHz

GENERAL INFORMATION

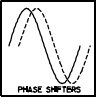

Merrimac offers an extensive line of manual, electronic, digital and precision phase shifters for both systems and laboratory applications covering frequencies from below 200 kHz to beyond 3 GHz.

Mechanical Phase Shifters - PS* series

All Merrimac mechanical phase shifters incorporate a lumped element quadrature hybrid together with a matched pair of L-C networks to realize variable phase shifts. As seen in Figure 1, variable L-C networks linked to output ports 2 and 3 of a quadrature hybrid act as sliding short circuits. Placed at the output ports of the hybrid, these short circuits reflect incident energy back towards the source. The reflected energy appears at port 4, the isolated port, essentially unattenuated.

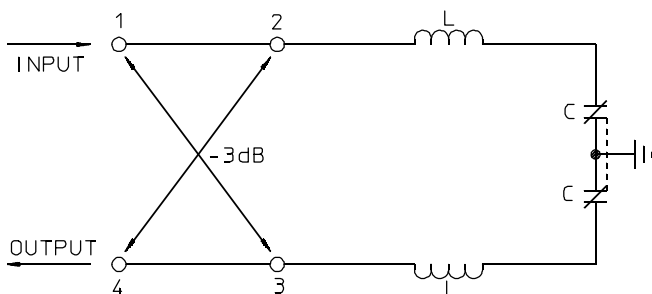

Figure 1. Mechanical Phase Shifter Section

The *sliding short* is varied across an electrical range by varying the capacitors which causes the phase angle of the reflected signal to vary by up to $2f$. By properly selecting the L-C elements, a one-way phase range of 90° can be obtained and an overall phase shift of 180° is realized. Phase shifts of 360° can be realized either by connecting a $0^\circ/180^\circ$ phase reversing switch in tandem with a 180° continuously variable phase shifter, or by connecting two $0^\circ-180^\circ$ continuously variable types together on a common shaft.

Electronic Phase Shifters - PE* series

Electronically controlled, continuously variable phase shifters operate similarly to the manual phase shifters described above. The principal difference is that voltage variable capacitors (varactors) are used instead of manually adjusted capacitors. To achieve the desired phase shift range, identical

units are connected in series. Figure 2 illustrates a typical electronically variable phase shifter.

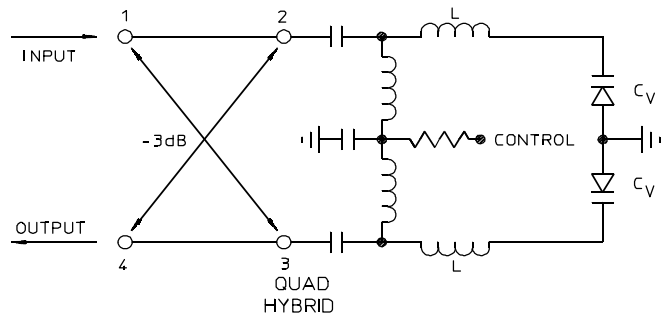

Figure 2. Electronic Phase Shifter Section

Electronic phase shifters are available in a variety of packages and are suitable for use in systems requiring automatic phase control, closed loop feedback networks and steering of electronically scanned antennas.

Digital Phase Shifters - PT* & PW* series

This series of phase shifters is designed to be controlled directly from TTL circuits and is available for center frequencies from 10 MHz to 3 GHz. Phase shift is provided in binary sequenced increments from LSB (least significant bit) to the MSB (most significant bit). Units are designed in either digital switched sections for the optimum absolute accuracy (PTM series), or as a D/A converter driving analog phase shifters for guaranteed monotonicity (PWM series).

Limitations and Trade Offs

Center Frequency

The center frequency depends on the type of quadrature hybrid used. The low frequency limit of mechanical phase shifters is set by the insertion loss of the resonant network and the availability of manually variable capacitors with an adequate max-min ratio. The high frequency limit is set by the physical size of the variable capacitor. The high frequency limit of electronic phase shifters is limited by stray capacitances and circuit Q's.

VSWR and Bandwidth

Bandwidth is controlled by the type of quadrature hybrid used. VSWR generally deteriorates at the band edges. If the quadrature hybrid is optimally designed, VSWR is controlled by the tracking of the capacitors (or varactors) in the resonant network. For those units using a piston trimmer as the variable capacitor, the plate-to-plate capacitance forms an additional RF path which may result in poor VSWR when a broadband quadrature hybrid circuit is used. Therefore, phase shift is generally limited to 90° and bandwidths are limited to 10% except on specially tailored units available on custom orders.

Phase Shift Range

For mechanical phase shifters, a limited number of variable capacitor styles are available. This limits the options available in custom designs. In contrast, for electronic phase shifters, the range of phase shift is theoretically unlimited and useful range is governed by the limits imposed by acceptable insertion loss.

Phase Shift vs. Control Characteristic

Since variable capacitors are not generally available with unusual tapers except in very large quantities, custom characteristics are generally unavailable. For electronic phase shifters, the phase shift vs. control curve can be linearized using a multi-section approach where only the linear portion of each section is used. The cost of this approach is increased insertion loss. Alternatively, a specific transfer characteristic curve can be guaranteed from unit-to-unit for which the user may then design a linearizing drive circuit.

Bias polarity for electronic phase shifters

Standard polarity is positive. However this may be reversed to meet specific customer requirements.

Group Delay Flatness (phase linearity)

Phase shifters in which no inductors are used are phase linear. However, the maximum phase shift obtainable is thus limited to approximately 90°. If more phase shift is desired, several stages can be cascaded in electronic phase shifters provided the insertion loss is acceptable. This approach is used in some digital phase shifters. In mechanical phase shifters, limited availability of ganged variable capacitors preclude this approach.

Power

The power handling capacity of mechanical phase shifters is limited primarily by the Q of the L-C resonant network. Typically, for a 180° unit, this network contributes loss of 0.5

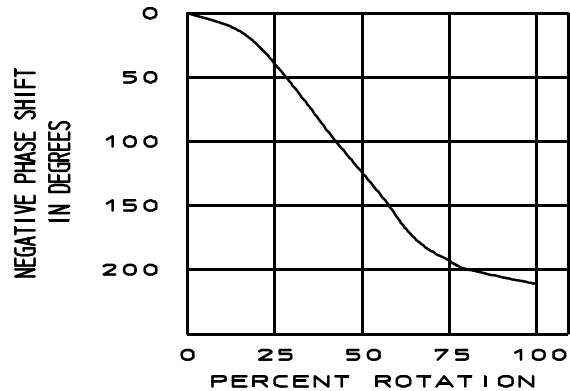

Figure 3. Typical Phase Shift vs. Rotation

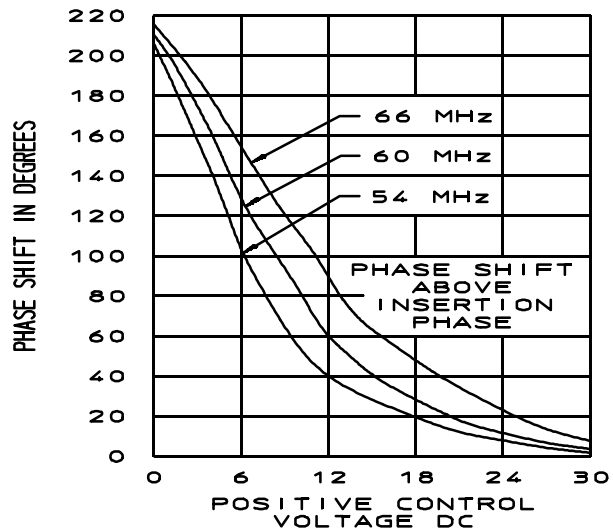

Figure 4. Typical Phase Shift vs. Control Voltage

dB or roughly half the total loss of the unit. At 10 watts input, for example, approximately 1 watt must be dissipated by the two inductors. High Q inductors are required for high power designs and heat sinks may also be needed.

The power handling capacity of electronic phase shifters is set primarily by the operating bias. At zero bias, most varactors begin to rectify at 0 dBm. When this occurs, the unit insertion loss rises and a reverse bias must be applied. Applying reverse bias, however, reduces available phase shift range. Units can be built to operate at levels as high as +10 dBm on special order.

Parameter Definitions

Phase Shift Range, Manually Variable Models:

The minimum total phase shift, in electrical degrees, that results from varying the manual control from minimum to maximum settings. The phase shift range specified is that phase shift available in addition to the fixed insertion phase shift which is the inherent phase shift between the device's input and output ports.

Phase Shift Range, Electronic (Analog) Models:

The minimum total phase shift, in electrical degrees, that results from varying the control voltage through its full range from minimum to maximum. The phase shift range of most Merrimac electronic phase shifters is in a *negative* direction in degrees, (i.e. insertion phase decreases as control voltage increases).

Insertion or Transfer Phase:

The difference in phase between input and output ports. For mechanical and digital phase shifters, the insertion phase occurs at the minimum setting. For the analog electronic phase shifters, the insertion (minimum) phase occurs at the maximum control voltage.

Phase Shift vs. Frequency (Group Delay):

Merrimac phase shifters are not constant phase or devices that are *flat* with frequency. For any given setting of phase shift, whether manual or voltage controlled, as frequency varies, the value and slope of phase shift changes as a function of frequency, as shown in Figure 5.

Phase Shift vs. Control Characteristic:

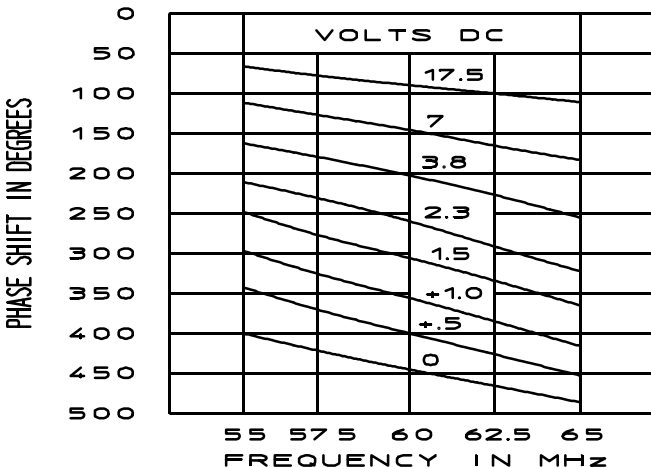

Figure 5. Typical Phase Shift vs. Frequency

This parameter, applicable in particular to custom electronic phase shifters, is the deviation of the transfer function (phase vs. volts) from the best fit straight line.



Control Voltage Range (Electronic Phase Shifters)

The DC voltage range required to shift phase from maximum to minimum. Additionally, this parameter sets the maximum voltage that may be applied to the device without damage.

Phase Stability Versus Temperature (Figure 6):

The maximum rate of change in insertion phase at any frequency over the specified temperature range.

Insertion Loss (Figure 7):

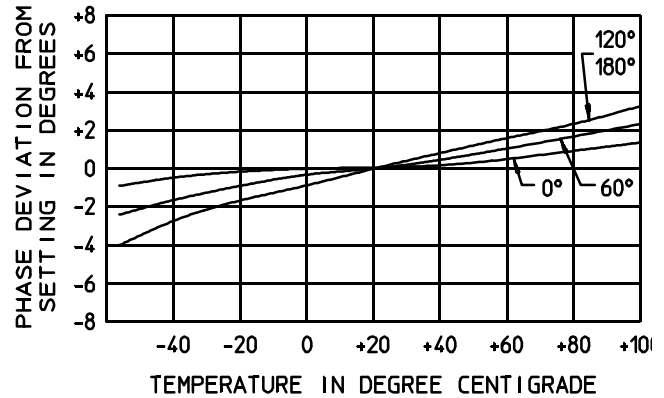

Figure 6. Typical Phase vs. Temperature

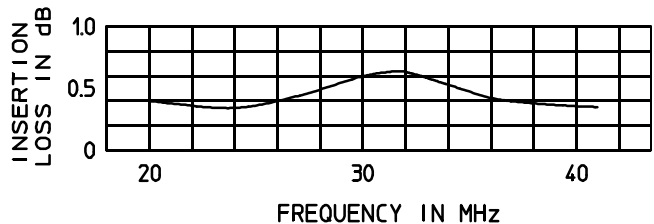

Figure 7. Typical Insertion Loss

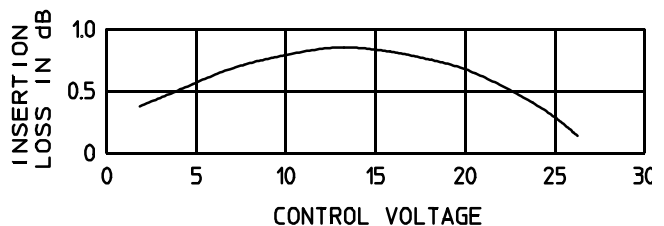

Figure 8. Typical Loss vs. Control Variation

The ratio of unrecoverable power (dissipated within the circuit) to input power, expressed in dB, at a given frequency.

Insertion Loss Variation Versus Control Voltage:

The maximum change of insertion loss from all causes experienced as the control input voltage is varied over its specified range (Figure 8).

Settling Time (Electronic & Digital Phase Shifters):

The maximum time interval starting with application of the control input until the output attaining 95% of its final value including overshoot and ringing.

Modulation Rate:

The modulation rate is the inverse of settling time. For phase shifters, the specified modulation rate is limited to about 1% of the center frequency. Phase modulators in the PMP and PLM series have been designed for much higher rates of modulation.

Phase Shift Accuracy, Digital Units:

The maximum phase error between the theoretical and actual phase shift for any combination of bits.

VSWR:

The maximum voltage standing wave ratio at all ports for any phase setting under matched load conditions.

Input Power:

The maximum CW (or peak, as specified) power that may be applied without degrading performance specifications such as insertion loss or VSWR.

Special Digital Considerations

Digital phase shifters are designed to be driven by normal binary inputs. To be driven adequately, Merrimac phase shifters require standard TTL levels. Customers requiring other logic families (e.g., CMOS, ECL, etc.) should order Merrimac units configured with the appropriate converters.

Merrimac Digital Phase Shifters are available in three basic design schemes:

1) The PTB & PTM-64A series are **quadrature hybrid designs** in which quadrature hybrid phase shift sections are cascaded. Each section has a different phase shift maintaining a binary sequence relationship to the others. The key features

of this type of phase shifter include fast response time and low insertion loss.



2) The PTB & PTM-84A/B series are **switched cable designs** using PIN diode switches. These units feature broad bandwidth and provide power handling capability up to 10 dBm.

3) The PWM-84C series converts the binary control signal to an analog voltage using a **digital-to-analog converter**. This voltage then drives a series of analog phase shifters. This approach assures monotonic output response and provides output frequencies up to 3 GHz.

Digital Phase Shifter Ordering Information

The following factors need be addressed in identifying and specifying a digital phase shifter.

1) **Operating Frequency:** Operating frequency is the principal specification and is especially important in the switched cable type of phase shifter. Phase linearity over wide bands is not possible in the quadrature hybrid type of phase shifters.

2) **Digital Word and Bit Values:** Total phase shift, least significant bit (LSB), most significant bit (MSB) and total number of bits all need to be specified in one form or another. For any unit, the total phase shift is equal to twice the most significant bit minus the least significant bit or $2(\text{MSB}) - (\text{LSB})$. The LSB defines the smallest increment of phase shift (the resolution or granularity) required of the phase shifter.

Bit	1	2	3	4	5	6	7	8
	(LSB)							(MSB)
Increment	1.40°	2.81°	5.62°	11.2°	22.5°	45°	90°	180°

3) **Accuracy:** Accuracy can be defined in a number of ways. Therefore, it is important to specify how the device is used. In a digital design, the phase shift accuracy of each bit can be set very closely; typically $\pm 0.1^\circ$. However, as total phase shift increases, total accuracy generally decreases. This results from the cumulative effect of multiple internal reflections in the unit. Of special importance is the **monotonicity**. Monotonic performance means phase shift *always* increases as the digital input command value increases. To achieve this, accuracy must be less than the LSB.

4) **Power Supply:** Since Merrimac digital phase shifters are TTL compatible, +5V DC Power is required. In the PTM-64A and PTM-84B series, a +15V supply is also required to assure the diodes are fully switched. However, this requirement can optionally be modified to allow this supply to be any fixed value in the range +10 to +30V. The PTM-84A switched cable type phase shifter has an advantage in that it operates with only a +5V supply. The power supply should have reasonably low

ripple, good regulation and be free of spikes. Most standard power supplies are quite adequate. However, if an unregulated +28V supply is used, a voltage regulator needs to be included at added cost.

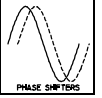

5) **Insertion Loss:** Insertion loss changes with phase shift for all types of digital phase shifters. Typically, the worst case change in loss is 0.8 dB. Optional compensation measures can be implemented to reduce this variation to less than 0.1 dB.

6) **Line Transients:** Signal line spiking will occur since switching takes place in the RF circuit. These transients will appear on the RF line synchronized with the leading and trailing edges of the control pulses. In the PTM-64 series, the quadrature hybrid behaves as a bandpass filter. Main line spikes are usually less than 100 mV. However, if the control signal rise time is sufficiently fast, a large transient component at f_0 may pass through the quadrature hybrid.

For example, if the rise time is 100 ns, the first component of the Fourier series is at 10 MHz. If the Phase Shifter is a 10 MHz unit, this component will be passed and appears as a mainline spike approximately equal to the voltage drop across a diode, $\approx 0.6V$. In the switched cable type phase shifter, i.e., PTM-84 series, no mainline filtering is included and a spike equal to the voltage drop across two series diodes, $\approx 1.2V$, may be expected.

7) **RF Power Capability:** RF power capacity is limited as a design choice. Using low power, low current diodes provides fast switching and considerable cost savings over costly, high power diodes. High power diodes typically have long minority carrier lifetimes and consequently relatively slow switching rates compared to the low power diodes used by Merrimac.