

TECHNICAL DESCRIPTION

FEATURES

- 1.0 - 2.0 GHz
- LOW LOSS
- HIGH ISOLATION
- EXCELLENT PHASE/AMPLITUDE BALANCE
- SURFACE MOUNT
- TAPE & REEL AVAILABLE

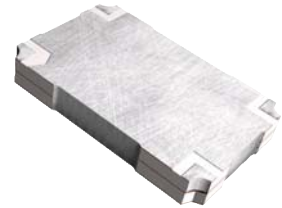

The Multi-Mix[®] QHD series provides a 3 dB 90° coupling with low insertion loss, low VSWR, and high isolation. Accurate phase and amplitude balance make this series ideal for use in IQ networks, power amplifiers, radio transceivers, receiver multicouplers and RF signal distribution and processing equipment.

QHD quad hybrids are fusion bonded multilayer stripline devices. The fusion bonding process yields a homogeneous monolithic dielectric structure with reliability, ruggedness, and electrical performance that is superior to conventional adhesive bonding techniques.

GENERAL SPECIFICATIONS

FREQUENCY RANGE MHz		INSERTION LOSS (dB MAX)	AMPLITUDE BALANCE (dB MAX)	PHASE BALANCE	ISOLATION (dB MIN)
1200 - 1850		0.20	± 0.50	90 ± 2°	23
1400 - 1700		0.18		90 ± 2°	23
1000 - 2000		0.25		90 ± 3°	20
VSWR (ALL PORTS)	INPUT POWER (CW @ 1.2:1 OUTPUT VSWR)	SIZE (INCHES)	WEIGHT (OZ./GRAMS)	RF INTERFACE	OPERATING TEMPERATURE
1.20:1 1.15:1 1.20:1	200 W	0.56 x 0.35 x 0.080	0.03 / 0.8	Surface Mount	-55° - +95° C

PACKAGE OUTLINE / TAPE & REEL ORIENTATION

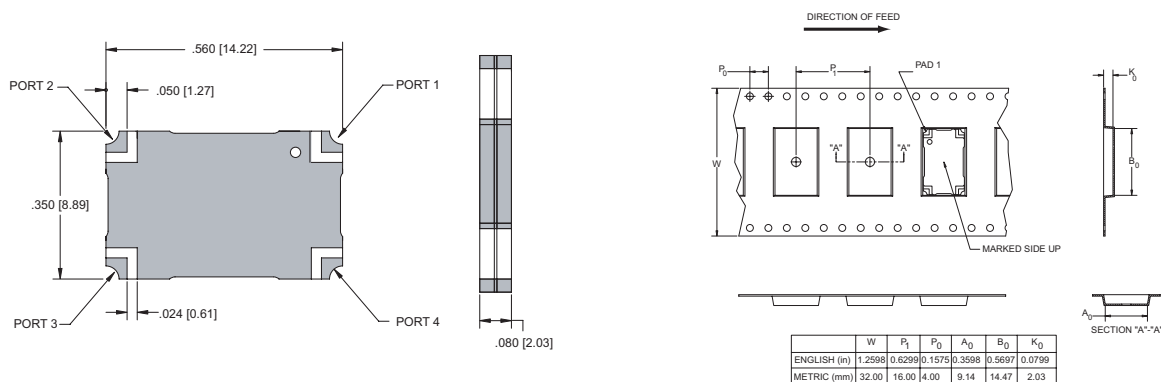

THE MULTI-MIX MICROTECHNOLOGY[®] GROUP IS ISO 9001:2000 REGISTERED



U.S. Patent 6,099,677 and other Patents Pending.

TYPICAL PERFORMANCE

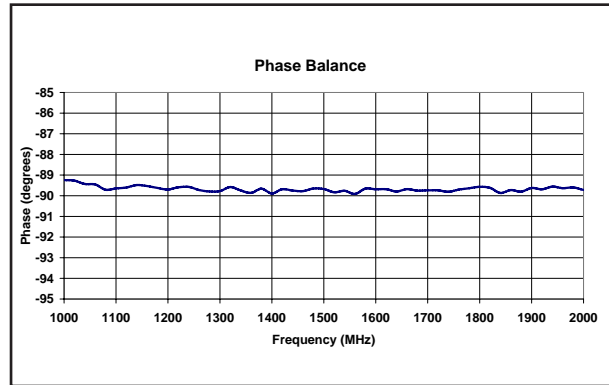
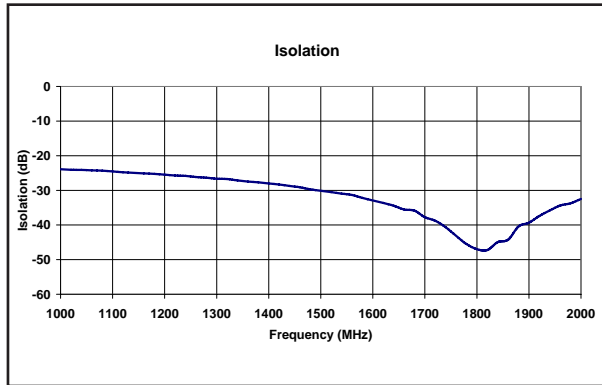
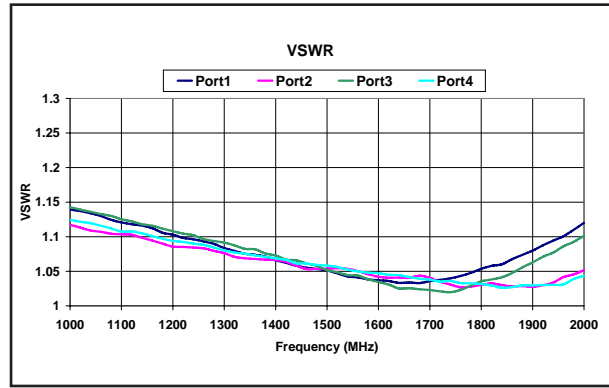
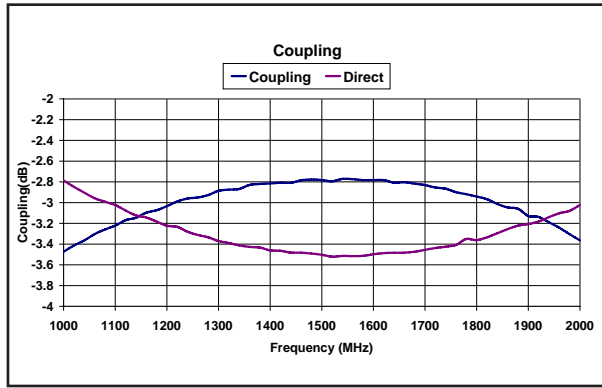

MOUNTING CONFIGURATION

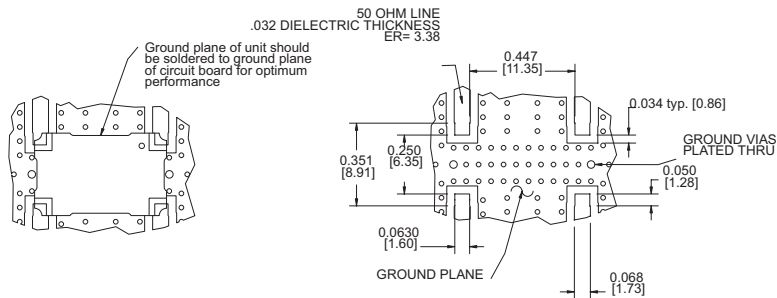

TRUTH TABLE

	1	2	3	4
1	Input	Iso	-90°	0°
2	Iso	Input	0°	-90°
3	-90°	0°	Input	Iso
4	0°	-90°	Iso	Input