

TECHNICAL DESCRIPTION

FEATURES

- 960 - 1220 MHz
- LOW LOSS
- HIGH DIRECTIVITY
- EXCELLENT COUPLING ACCURACY
- SURFACE MOUNT

APPLICATIONS

- JTRS



The Multi-Mix® CSDZ series provides 20 dB coupling at 1100 MHz. The CSDZ series features accurate coupling factors, low VSWR, and high directivity. Very low insertion loss and high power handling capability make this series ideal for use in base station power amplifiers particularly in the main loop of the feedforward amplifiers. The CSDZ series is also ideal for use in RF sampling networks and control circuitry in high power transmitters.

CSDZ directional couplers are based on fusion bonded multilayer stripline structures. The fusion bonding process yields homogeneous monolithic dielectric structures with reliability, ruggedness, and electrical and thermal performance that are superior to conventional adhesive bonding techniques.

GENERAL SPECIFICATIONS

FREQUENCY RANGE (MHz)	INSERTION LOSS (dB MAX)	MEAN COUPLING (dB)	VSWR (MAX, ALL PORTS)	
960 - 1220	0.25	20 ± 0.6	1.15:1	
FREQUENCY SENSITIVITY (dB MAX)	DIRECTIVITY (dB MIN)	AVERAGE POWER (WATTS, MAX.)	RF INTERFACE	OPERATING TEMPERATURE
± 0.30	20	200	Leadless Surface Mount	-55° TO +95° C

PACKAGE OUTLINE/ TAPE & REEL ORIENTATION

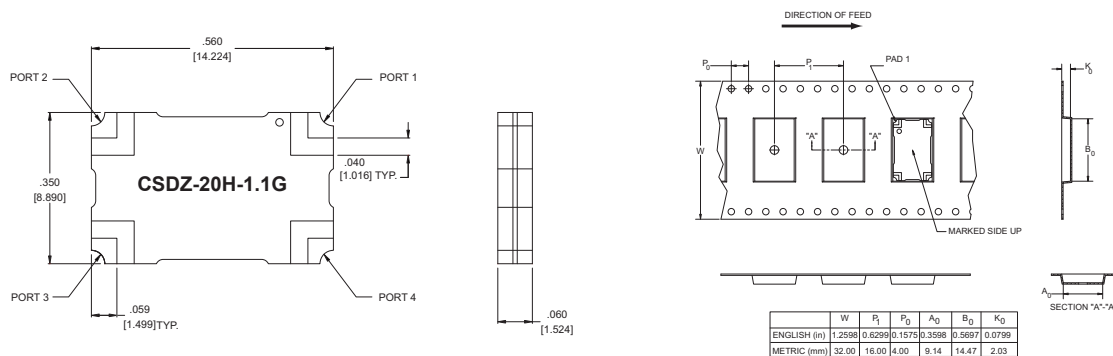

THE MULTI-MIX MICROTECHNOLOGY® GROUP IS ISO 9001:2000 REGISTERED

U.S. Patent 6,099,677 and other Patents Pending.

TYPICAL PERFORMANCE

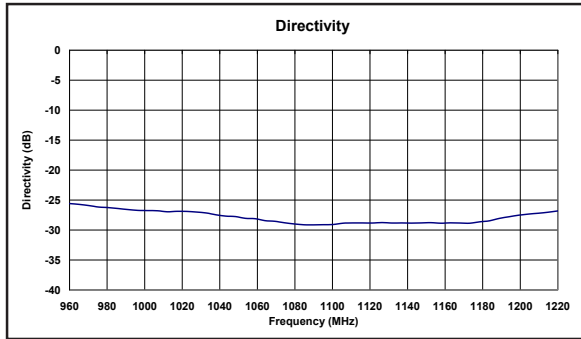
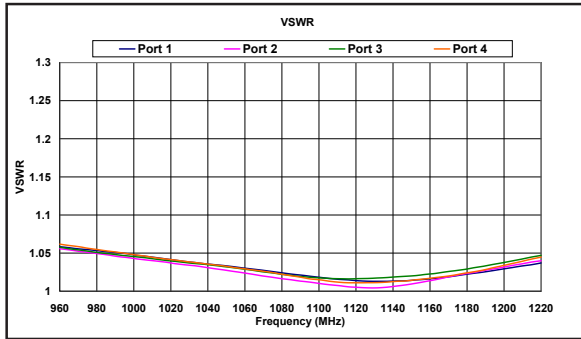
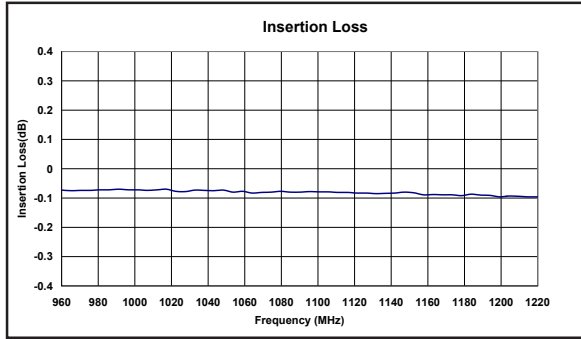
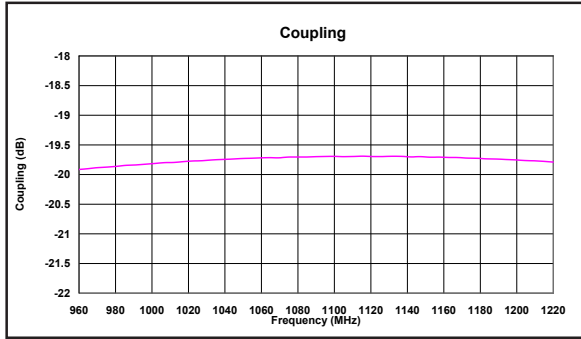

MOUNTING CONFIGURATION

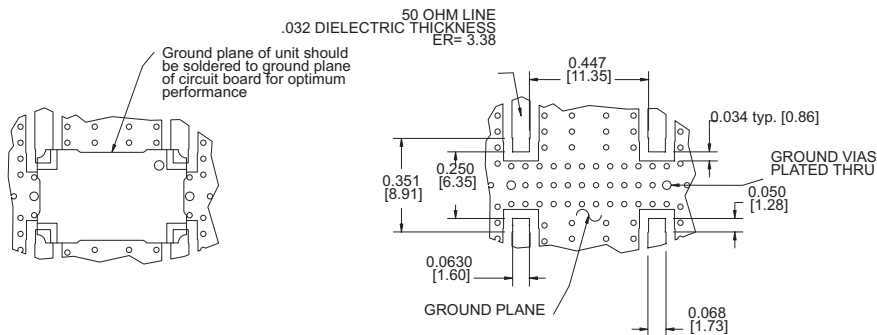

TRUTH TABLE

	1	2	3	4
1	Input	Output	Isolated	Coupled
2	Output	Input	Coupled	Isolated
3	Isolated	Coupled	Input	Output
4	Coupled	Isolated	Output	Input